

Goulds Pumps

PE Submersible Effluent Pump

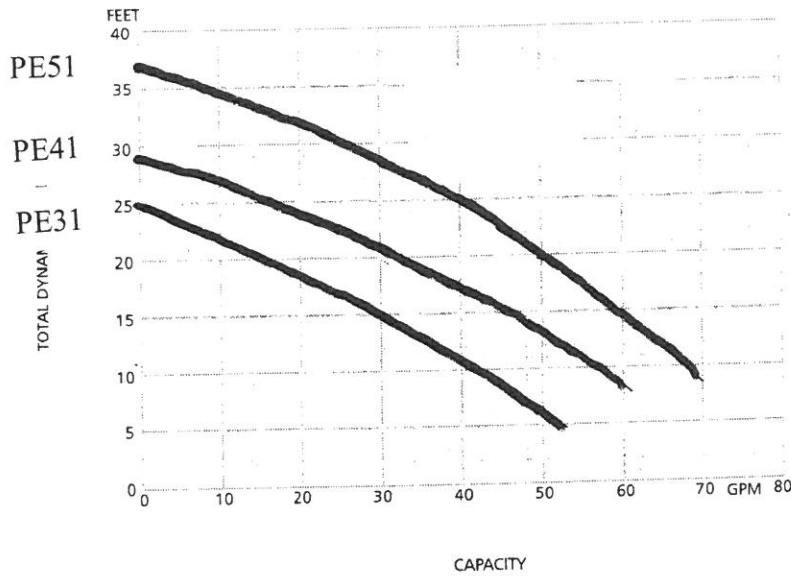
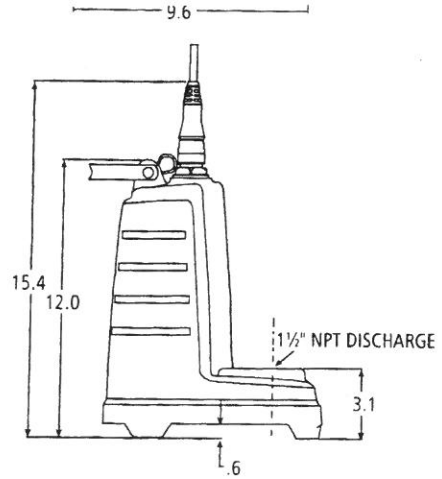
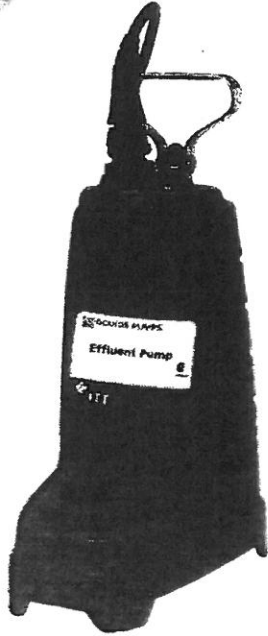

PUMP INFORMATION

Order No.	HP	Volts	Amps	Minimum Circuit Breaker	Phase	Float Switch Style	Cord Length	Discharge Connection	Minimum Basin Diameter	Maximum Solids Size	Shipping Weight lbs/kg
PE31M	0.33	115	12	20	1	Manual / No Switch	20'	1.5"	18"	.5"	31 / 14.1
PE31P1						Piggyback Float Switch					
PE41M	0.4	230	7.5	15		Manual / No Switch					
PE41P1						Piggyback Float Switch					
PE42M	0.4	230	3.7	10		Manual / No Switch					
PE42P1						Piggyback Float Switch					
PE51M	0.5	115	9.5	20		Manual / No Switch					
PE51P1						Piggyback Float Switch					
PE52M	0.5	230	4.7	10		Manual / No Switch					
PE52P1						Piggyback Float Switch					

WE

GOULDS PUMPS Wastewater

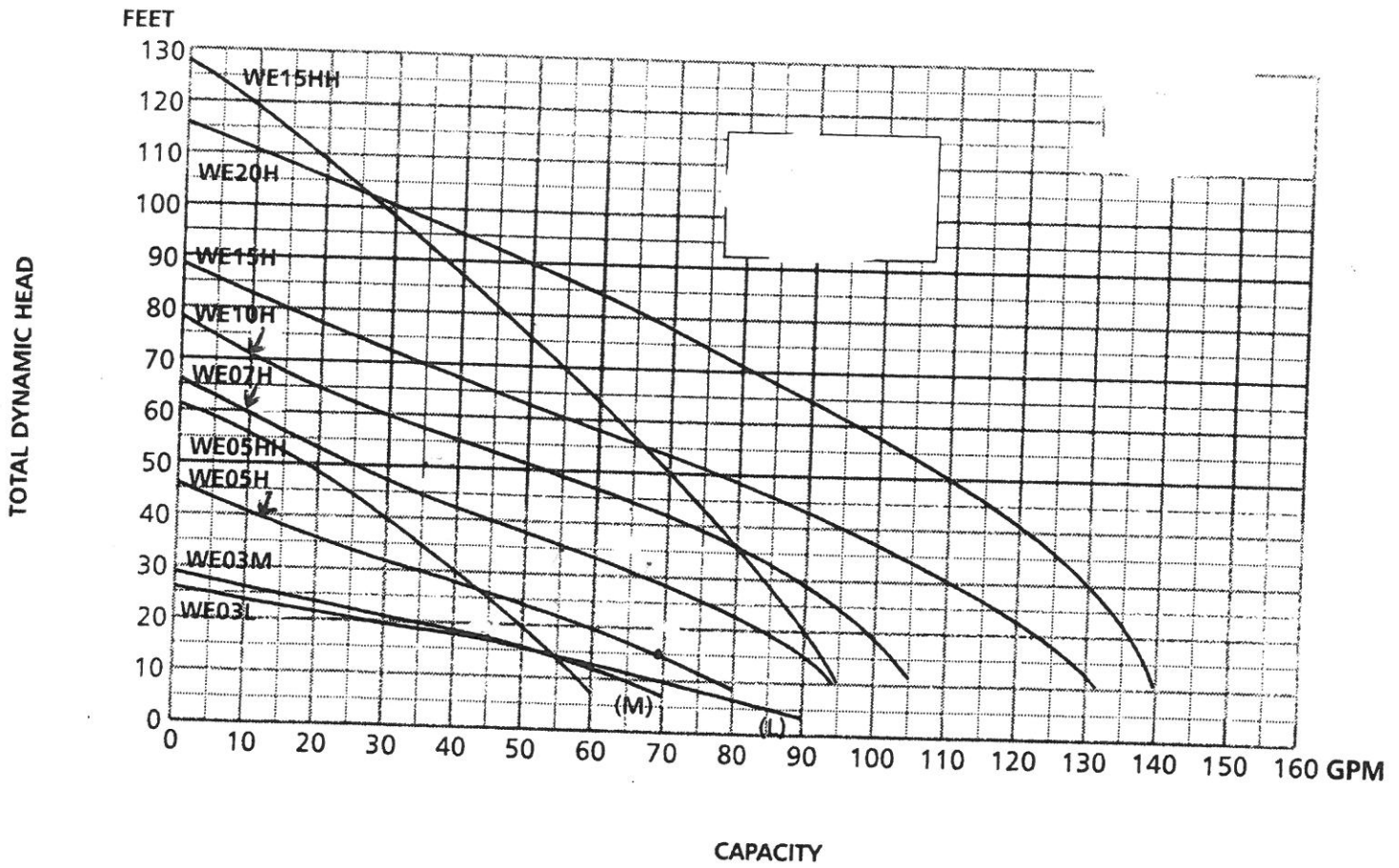

EP

GOULDS PUMPS Wastewater

MODEL INFORMATION

Order No.	HP	Volts	Amps	Minimum Circuit Breaker	Phase	Float Switch Style	Cord Length	Discharge Connection	Minimum On Level	Minimum Off Level	Minimum Basin Diameter	Maximum Solids Size	Shipping Weight lbs/kg	
EP0411	.4	115	12	20	1	Plug / No Switch	10'	1½"	Manual	Manual	15"	¾"	20 / 9.1	
EP0411A						Piggyback / Wide-Angle	10'	1½"	12"	6"	15"		21 / 9.5	
EP0411F						Plug / No Switch	20'	1½"	Manual	Manual	15"		20 / 9.1	
EP0411AC						Piggyback / Wide-Angle	20'	1½"	12"	6"	15"		21 / 9.5	
EP0412		230	6	10		Plug / No Switch	10'	1½"	Manual	Manual	15"		20 / 9.1	
EP0412F						Plug / No Switch	20'	1½"	Manual	Manual	15"		20 / 9.1	
EP0511F		.5	115	13		20	Plug / No Switch	20'	1½"	Manual	Manual		15"	22 / 10
EP0511AC							Piggyback / Wide-Angle	20'	1½"	12"	6"		15"	23 / 10.4
EP0512F	230		6.5	10	Plug / No Switch	20'	1½"	Manual	Manual	15"	22 / 10			

2

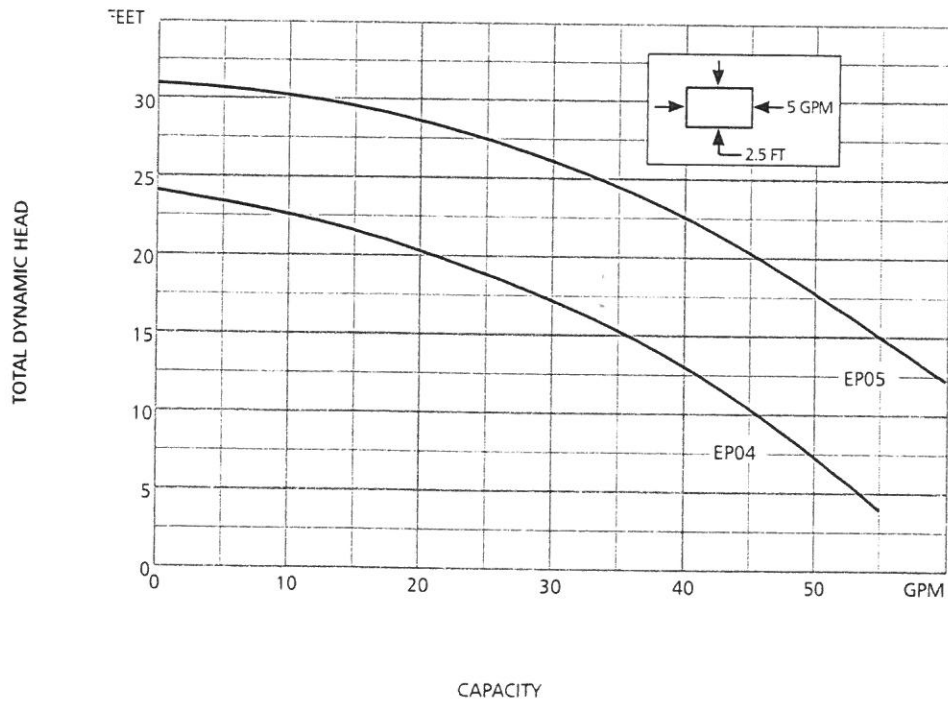

Liberty Pumps®

Pump Specifications

Series 1/2 hp Submersible Effluent Pump

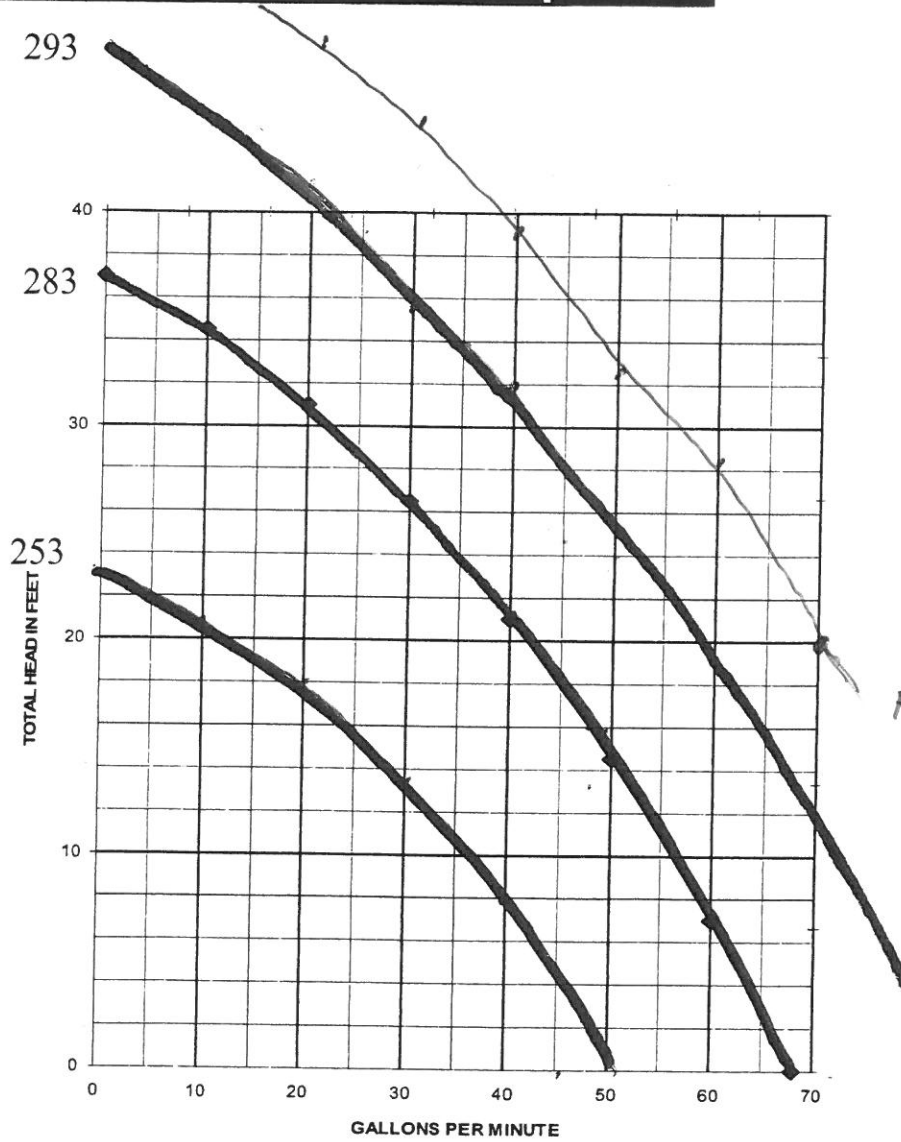
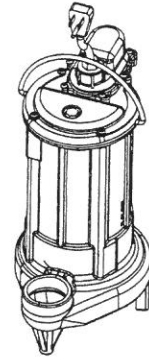

FL50 series 120V

Zoeller

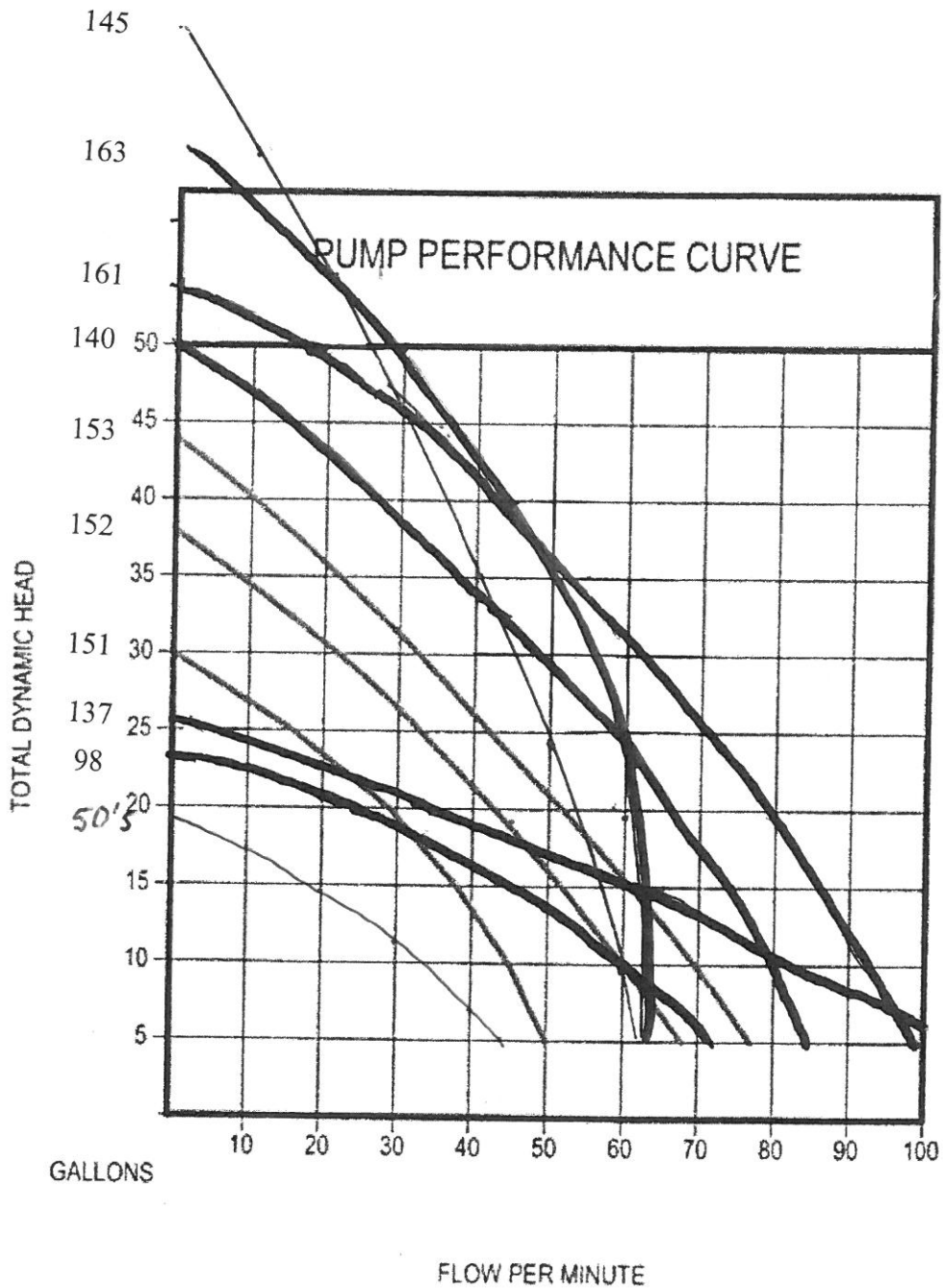

Hydromatic

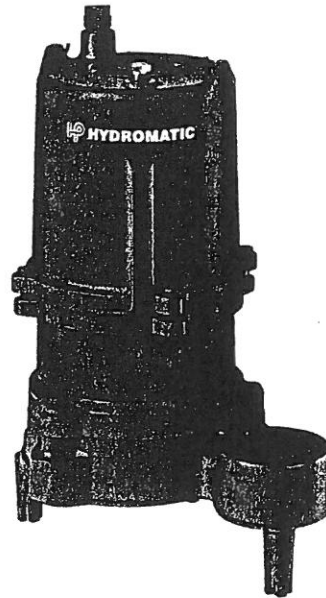

SHEF50	
Typical Application*	High Head Effluent and Dewatering
Capacities	to 63 GPM (4.0 l/s)
Heads	to 63 ft. (19.2 m)
Electrical	115V, 1 ϕ , 14.5 FLA, 60 Hz; 200/230V, 1 ϕ , 7.6 FLA, 60 Hz; 230V, 3 ϕ , 3.1 FLA, 60 Hz; 460V, 3 ϕ , 1.6 FLA, 60 Hz; 575V, 3 ϕ , 1.2 FLA, 60 Hz
Motor	(single phase) - 1/2 HP Split phase w/start capacitor and thermal overload protection, 3450 RPM ; (three phase) - 1/2 HP polyphase, 3450 RPM
Minimum Recommended Sump Diameter	Simplex = 24" (609.6 mm) Duplex = 30" (762 mm)
Automatic Operation	Wide-angle float switch (1 ϕ only) (manual available)
Materials of Construction	Class 30 cast iron
Impeller	Thermoplastic nonclog
Discharge Size	2" (50.8 mm)
Solids Handling	3/4" (19.1 mm)
Power Cord	1 ϕ - 20', SJTW, STW-A (30' optional); 3 ϕ - 20', STW-A (30' optional)

SHEF100	
Typical Application*	High Head Effluent and Dewatering
Capacities	to 88 GPM (5.5 l/s)
Heads	to 90 ft. (27.4 m)
Electrical	200V, 1 ϕ , 13.6 FLA, 60 Hz; 230V, 1 ϕ , 12.1 FLA, 60 Hz; 230V, 3 ϕ , 5.8 FLA, 60 Hz; 460V, 3 ϕ , 2.8 FLA, 60 Hz; 575V, 3 ϕ , 1.9 FLA, 60 Hz
Motor	(single phase) - 1 HP Split phase w/start capacitor and thermal overload protection, 3450 RPM ; (three phase) - 1 HP polyphase, 3450 RPM
Minimum Recommended Sump Diameter	Simplex = 24" (609.6 mm) Duplex = 30" (762 mm)
Automatic Operation	Wide-angle float switch (1 ϕ only) (manual available)
Materials of Construction	Class 30 cast iron
Impeller	Thermoplastic nonclog
Discharge Size	2" (50.8 mm)
Solids Handling	3/4" (19.1 mm)
Power Cord	1 ϕ - 20', SJTW, STW-A (30' optional); 3 ϕ - 20', STW-A (30' optional)

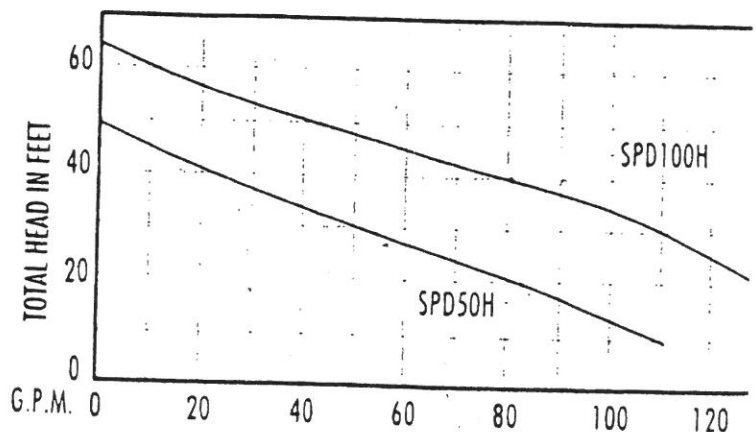
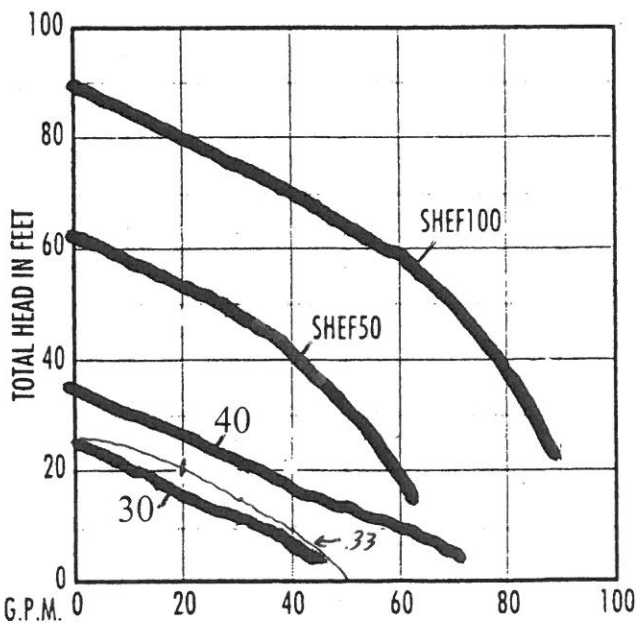

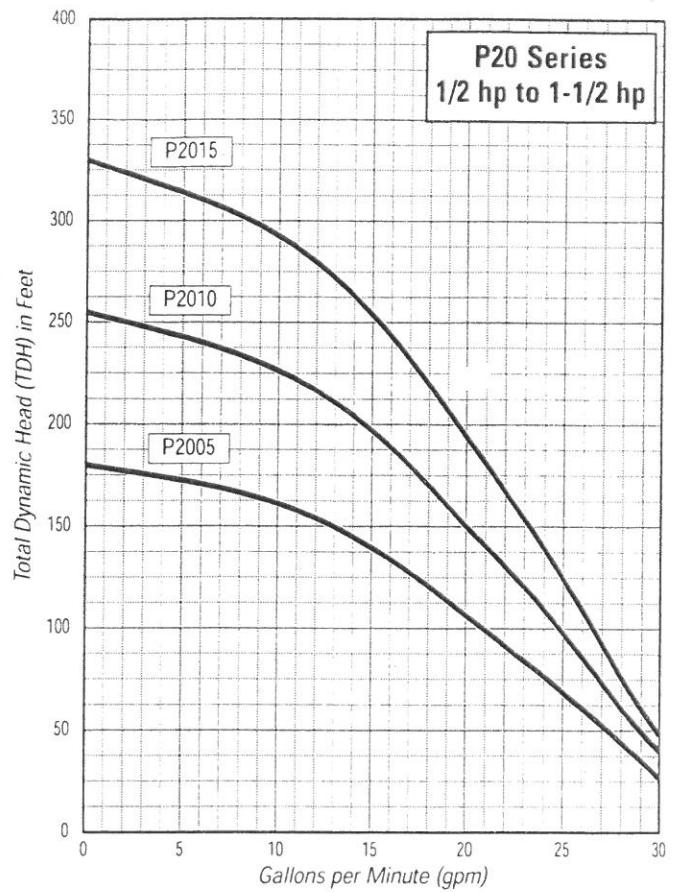
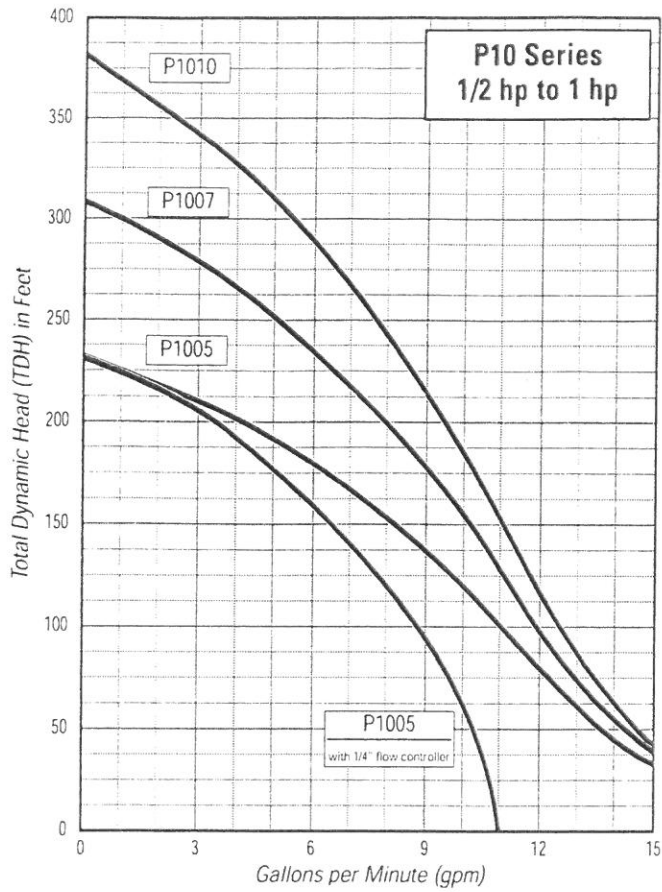

Orenco

